

ESCOLA _____ DATA: ____/____/____

PROF: _____ TURMA: _____

NOME: _____

COMO VOCÊ AJUDA SUA FAMÍLIA? CIRCULE.



ESCOLA _____ DATA: ____/____/____

PROF: _____ TURMA: _____

NOME: _____

COMO VOCÊ AJUDA SUA FAMÍLIA? CIRCULE.



ESCOLA _____ DATA: ____/____/____

PROF: _____ TURMA: _____

NOME: _____

PINTE A CENA DA FESTA EM FAMÍLIA.

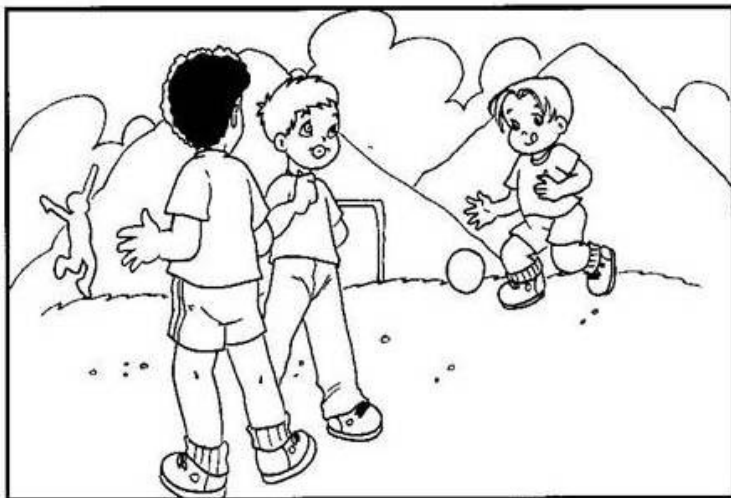

ESCOLA _____ DATA: ____/____/____

PROF: _____ TURMA: _____

NOME: _____

PINTE A CENA DA FESTA EM FAMÍLIA.

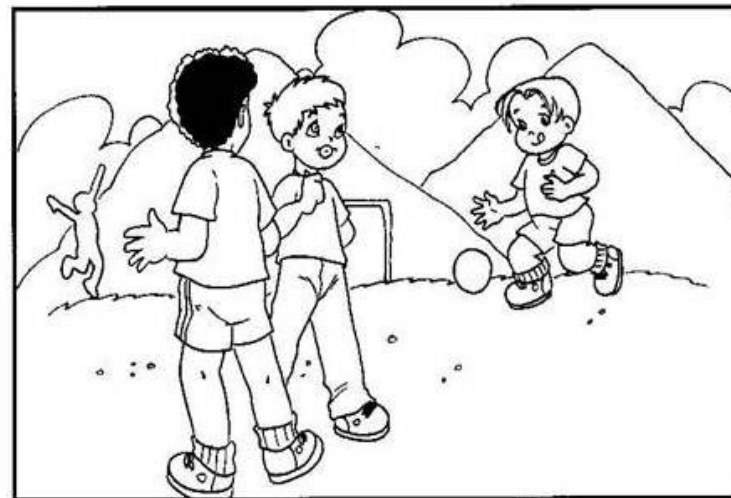

ESCOLA _____ DATA: ____/____/____

PROF: _____ TURMA: _____

NOME: _____

O QUE VOCÊ PREFERE PARA UM PASSEIO COM A FAMÍLIA?

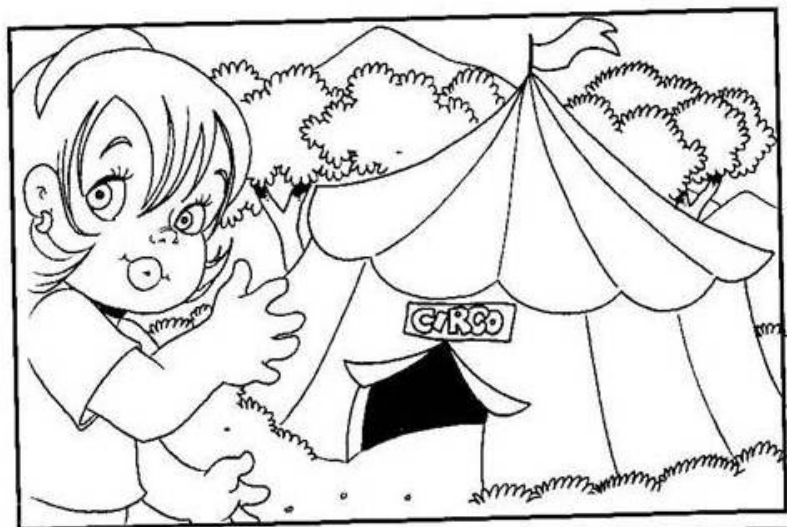

ESCOLA _____ DATA: ____/____/____

PROF: _____ TURMA: _____

NOME: _____

O QUE VOCÊ PREFERE PARA UM PASSEIO COM A FAMÍLIA?

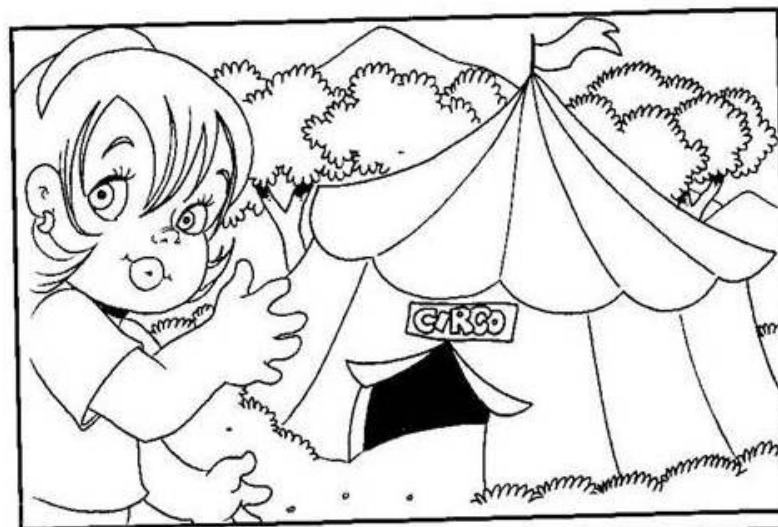

ESCOLA _____ DATA: ____/____/____

PROF: _____ TURMA: _____

NOME: _____

**SEUS PAIS SÃO MAIS VELHOS
OU MAIS JOVENS?
PINTE.**

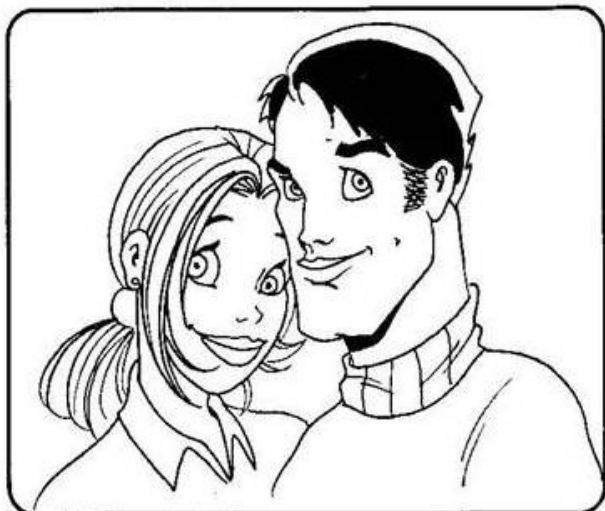

ESCOLA _____ DATA: ____/____/____

PROF: _____ TURMA: _____

NOME: _____

**SEUS PAIS SÃO MAIS VELHOS
OU MAIS JOVENS?
PINTE.**

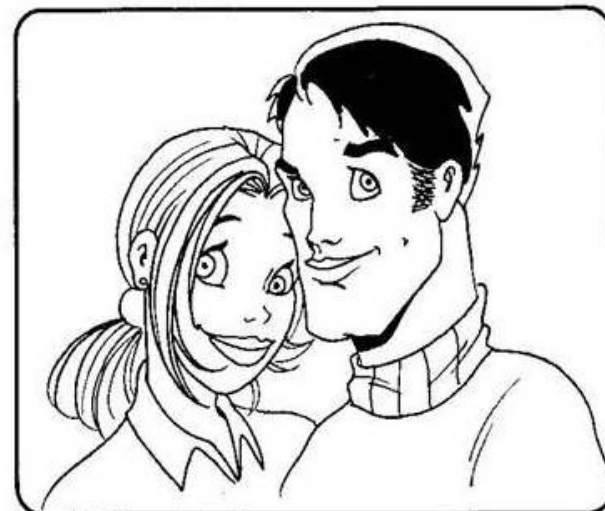

ESCOLA _____ DATA: ____/____/____

PROF: _____ TURMA: _____

NOME: _____

**FAÇA COLAGEM DE PESSOAS
PARA REPRESENTAR SUA FAMÍLIA.**

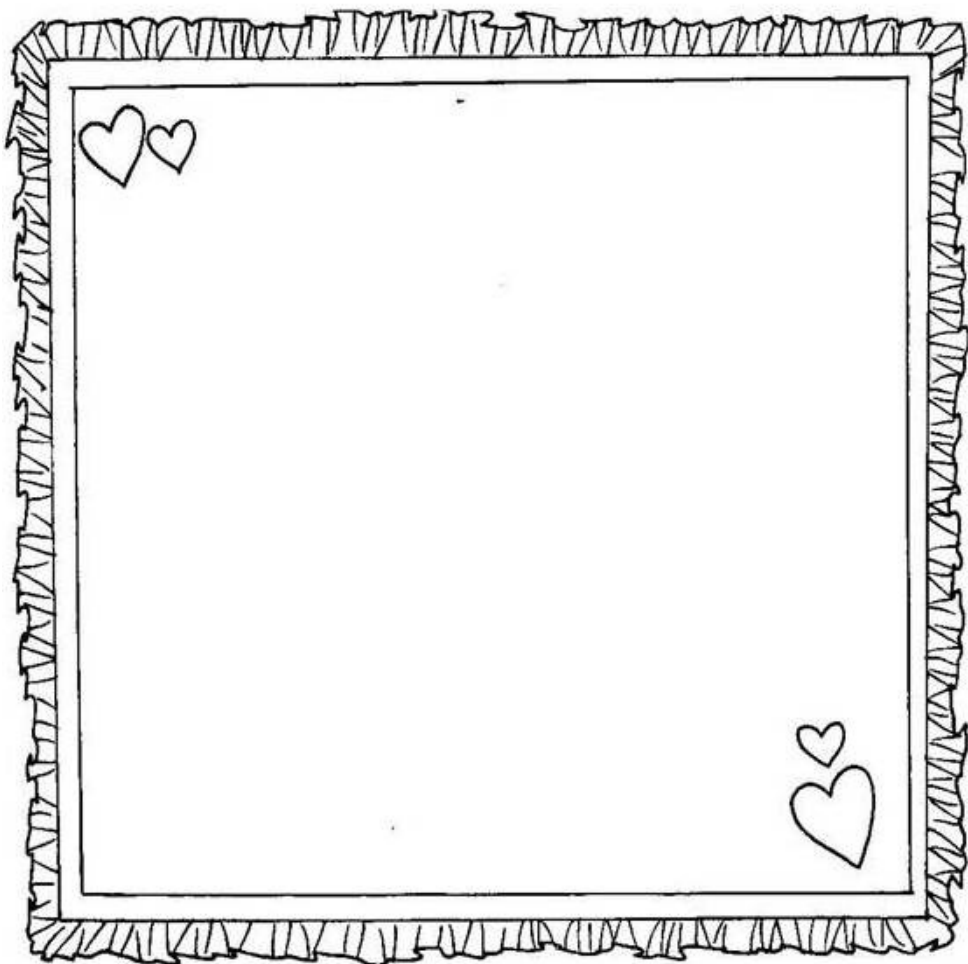

ESCOLA _____ DATA: ____/____/____

PROF: _____ TURMA: _____

NOME: _____

**FAÇA COLAGEM DE PESSOAS
PARA REPRESENTAR SUA FAMÍLIA.**

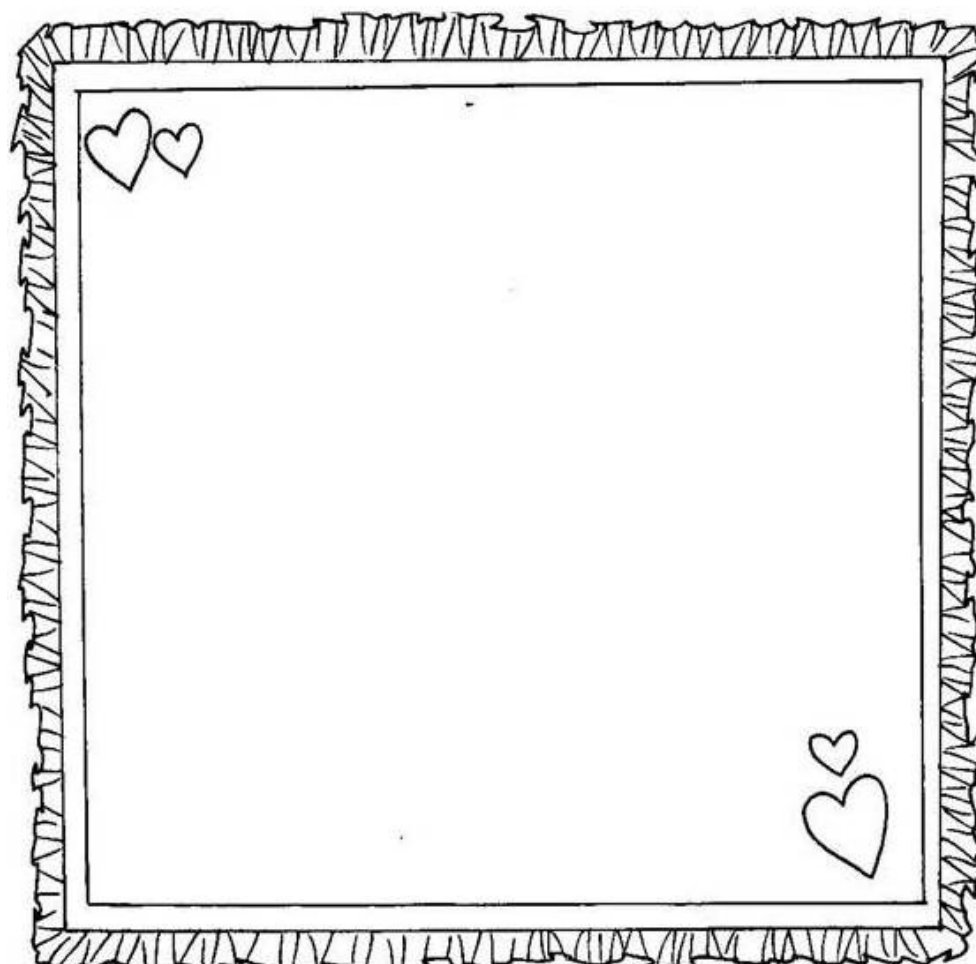

ESCOLA _____ DATA: ____/____/____

PROF: _____ TURMA: _____

NOME: _____

**MONTE OS FANTOCHES NO PALITO DE PICOLÉ.
DEPOIS CONTE UMA HISTÓRIA SOBRE SUA FAMÍLIA.**

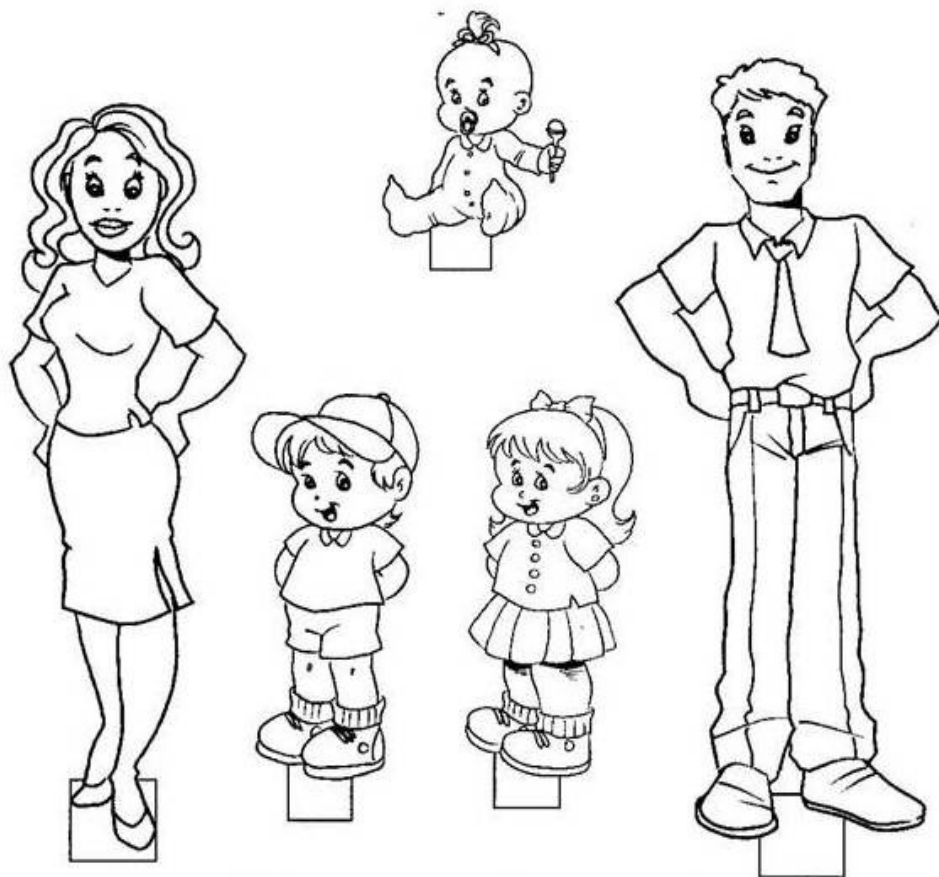

ESCOLA _____ DATA: ____/____/____

PROF: _____ TURMA: _____

NOME: _____

**MONTE OS FANTOCHES NO PALITO DE PICOLÉ.
DEPOIS CONTE UMA HISTÓRIA SOBRE SUA FAMÍLIA.**

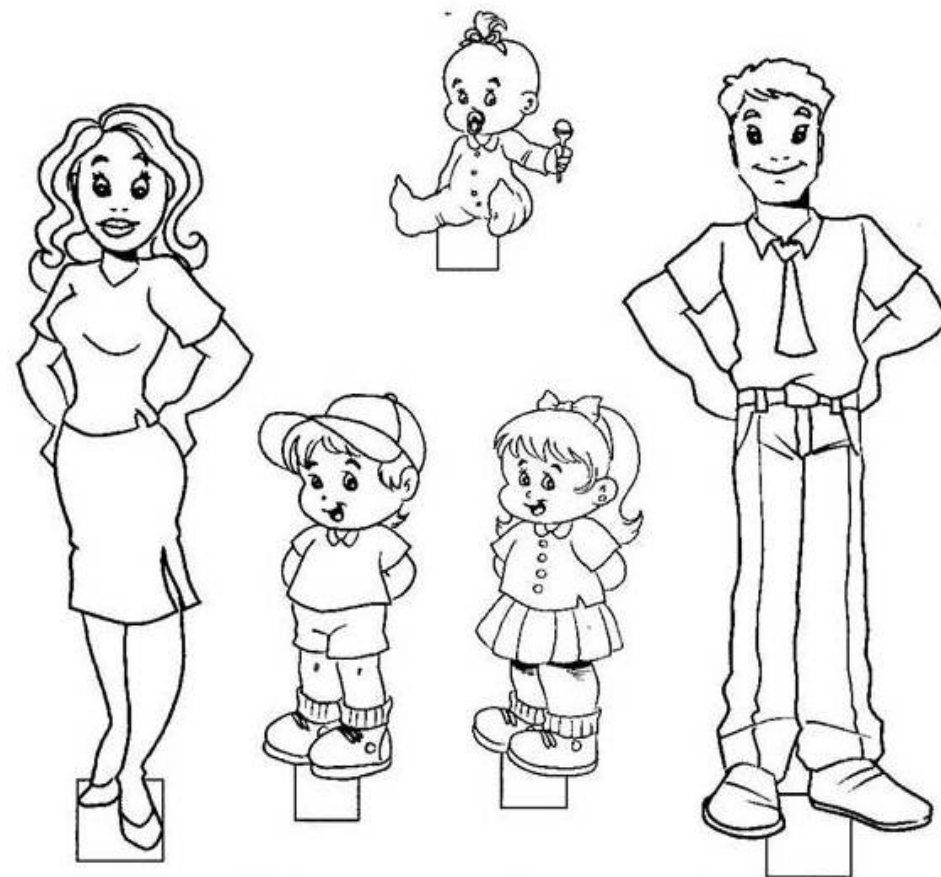

ESCOLA _____ DATA: ____/____/____

PROF: _____ TURMA: _____

NOME: _____

**DESENHE OU COLE NO PORTA-RETRATOS
QUEM FAZ PARTE DE SUA FAMÍLIA.**

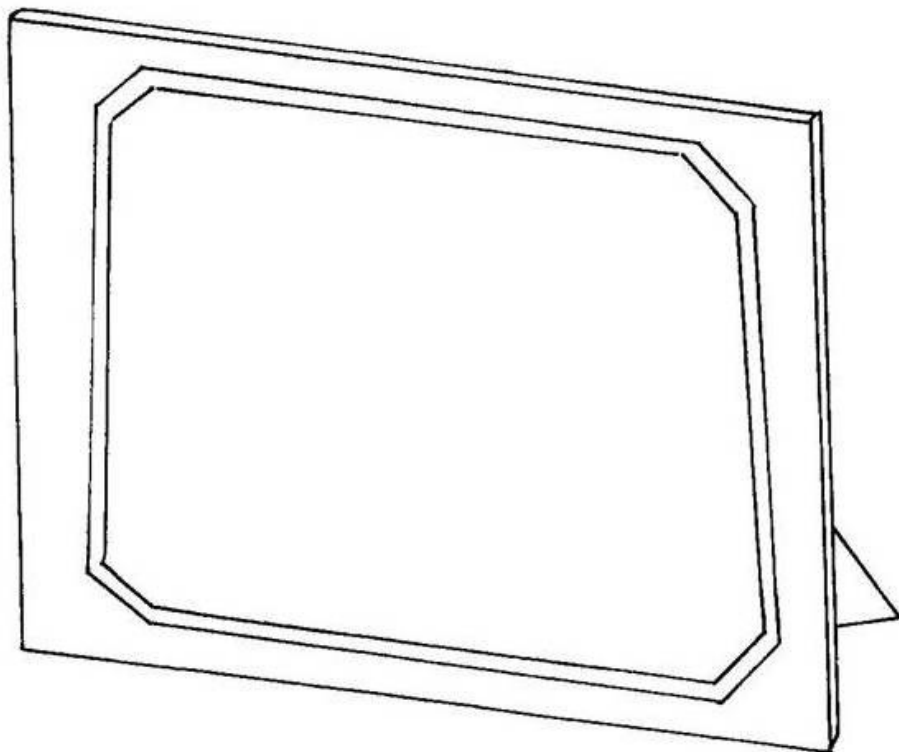

ESCOLA _____ DATA: ____/____/____

PROF: _____ TURMA: _____

NOME: _____

**DESENHE OU COLE NO PORTA-RETRATOS
QUEM FAZ PARTE DE SUA FAMÍLIA.**

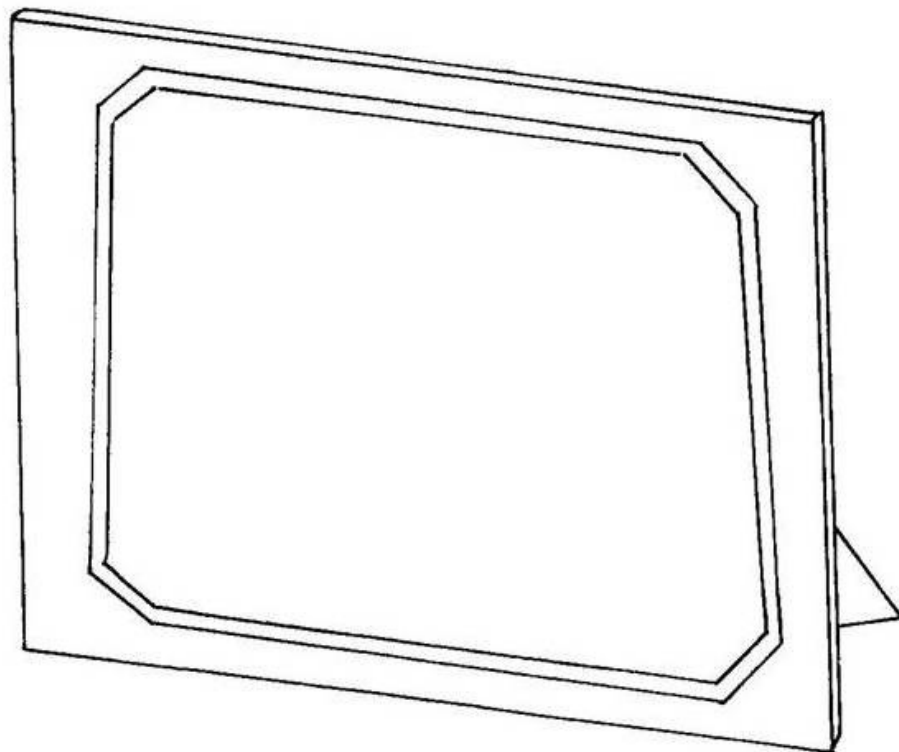

ESCOLA _____ DATA: ____/____/____

PROF: _____ TURMA: _____

NOME: _____

**QUE FAMÍLIA BONITA!
PINTE.**



ESCOLA _____ DATA: ____/____/____

PROF: _____ TURMA: _____

NOME: _____

**QUE FAMÍLIA BONITA!
PINTE.**



ESCOLA _____ DATA: ____/____/____

PROF: _____ TURMA: _____

NOME: _____

FAMÍLIA



ESCOLA _____ DATA: ____/____/____

PROF: _____ TURMA: _____

NOME: _____

FAMÍLIA



ESCOLA _____ DATA: ____/____/____

PROF: _____ TURMA: _____

NOME: _____

MINHA FAMÍLIA

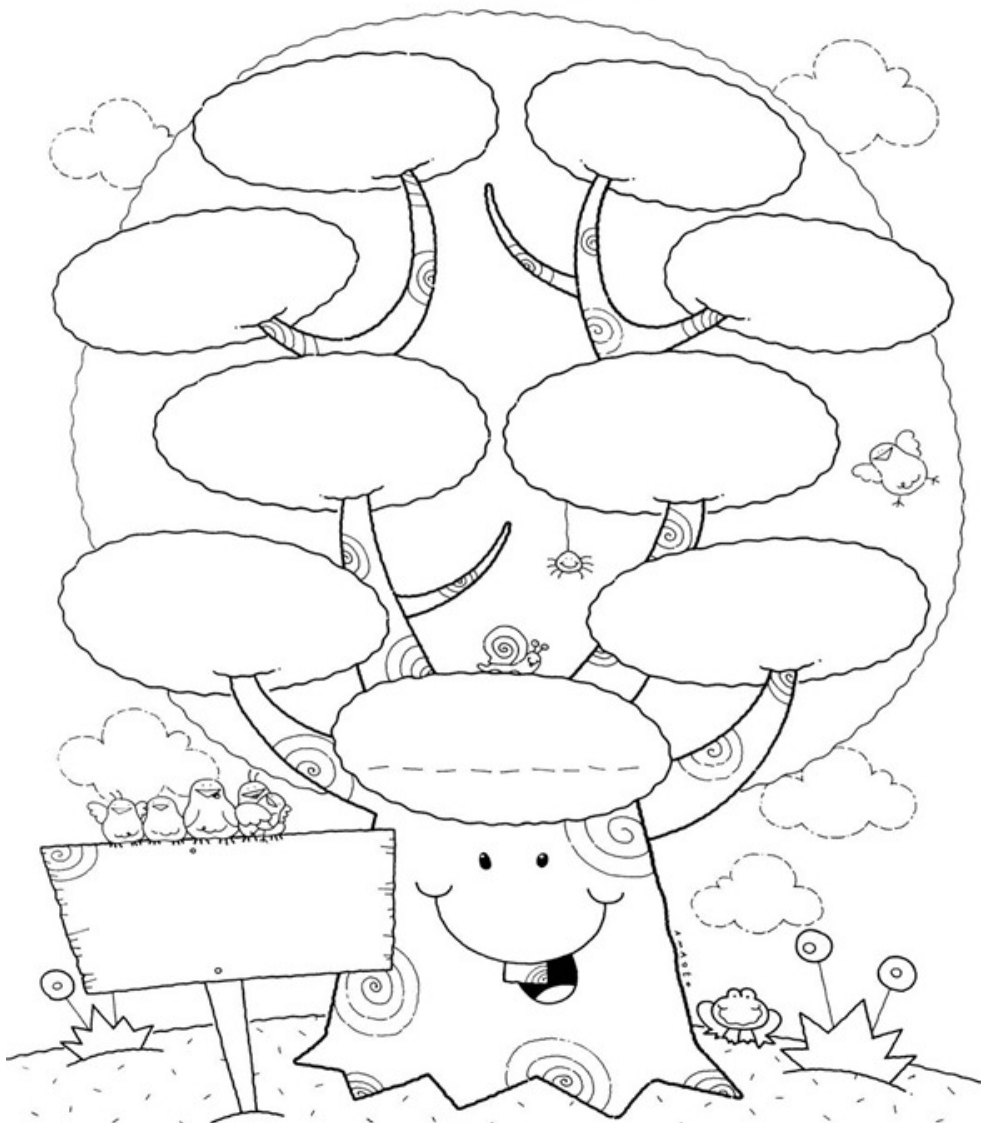

ESCOLA _____ DATA: ____/____/____

PROF: _____ TURMA: _____

NOME: _____

MINHA FAMÍLIA

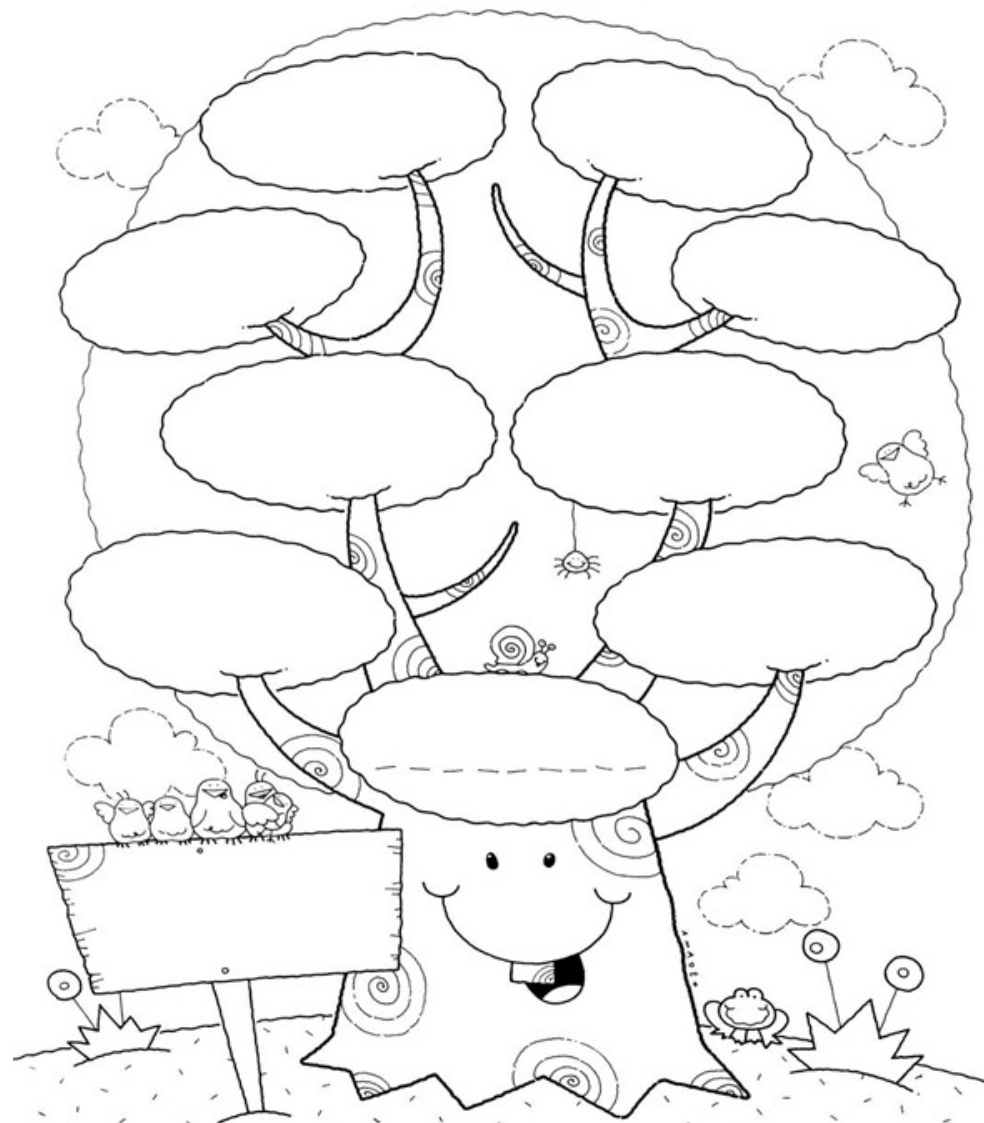

ESCOLA _____ DATA: ____/____/____

PROF: _____ TURMA: _____

NOME: _____

O QUE VOCE FAZ COM SUA FAMILIA?

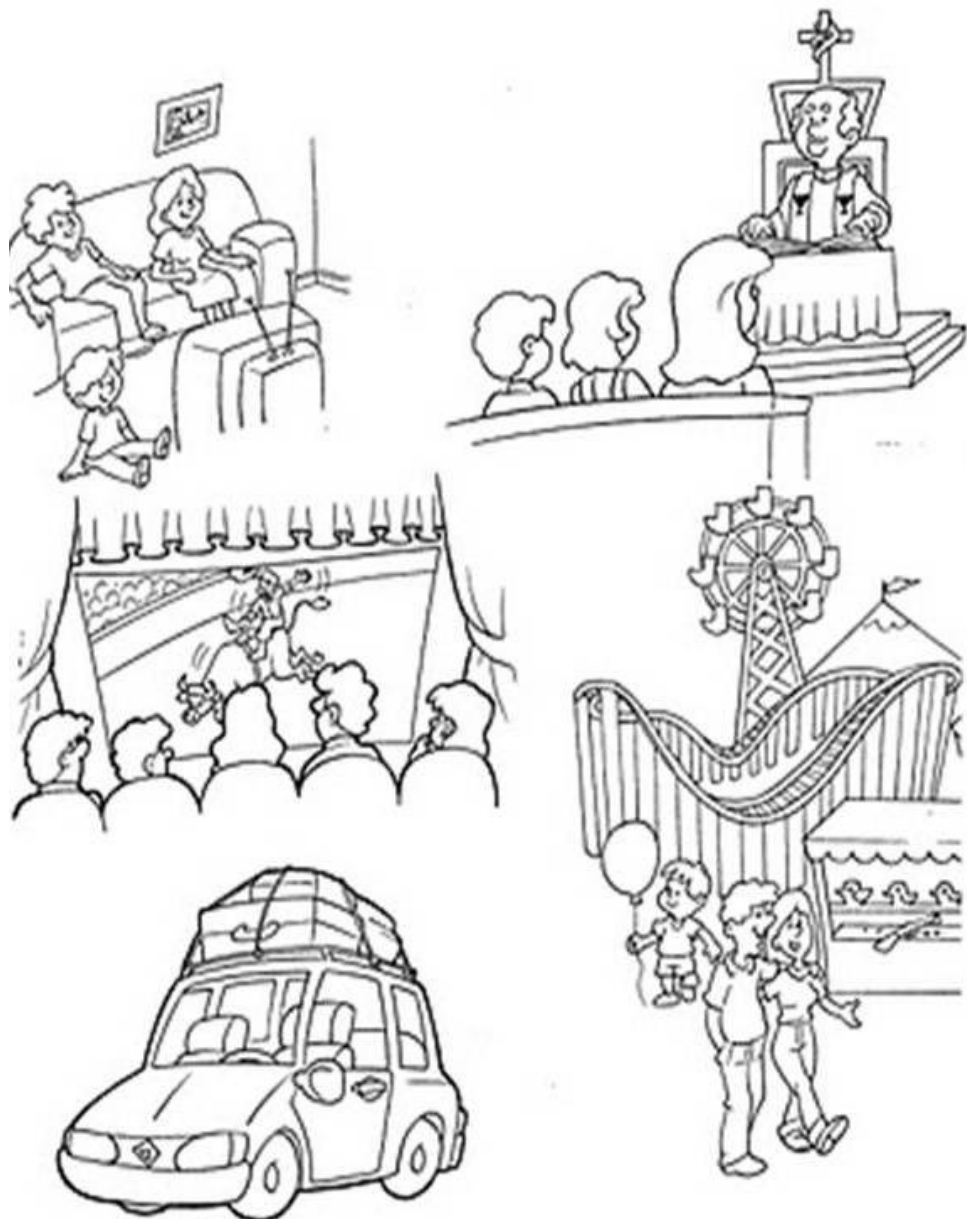

ESCOLA _____ DATA: ____/____/____

PROF: _____ TURMA: _____

NOME: _____

O QUE VOCE FAZ COM SUA FAMILIA?

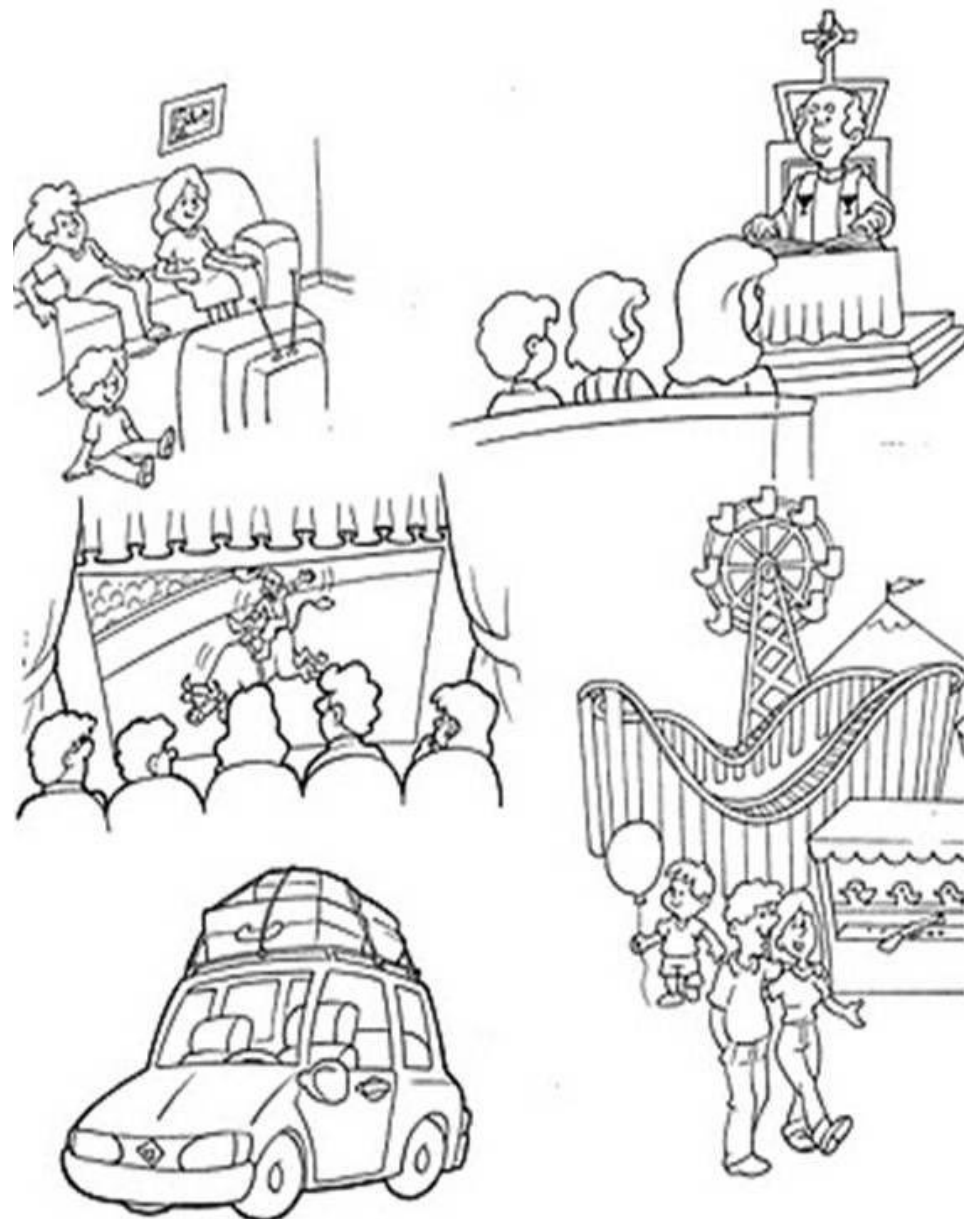

ESCOLA _____ DATA: ____/____/____

PROF: _____ TURMA: _____

NOME: _____

**PINTE ESTA FAMÍLIA E DESENHE A SUA
LOGO ABAIXO.**



ESCOLA _____ DATA: ____/____/____

PROF: _____ TURMA: _____

NOME: _____

**PINTE ESTA FAMÍLIA E DESENHE A SUA
LOGO ABAIXO.**



ESCOLA _____ DATA: ____/____/____

PROF: _____ TURMA: _____

NOME: _____

COMO VOCÊ AJUDA SUA MÃE? CIRCULE.

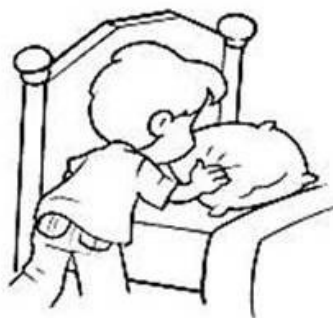

ESCOLA _____ DATA: ____/____/____

PROF: _____ TURMA: _____

NOME: _____

COMO VOCÊ AJUDA SUA MÃE? CIRCULE.

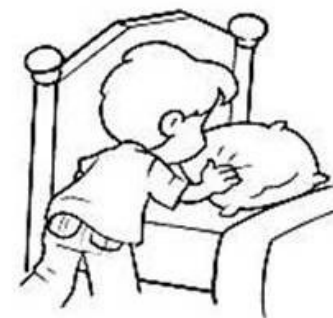

ESCOLA _____ DATA: ____ / ____ / ____

PROF: _____ TURMA: _____

NOME: _____

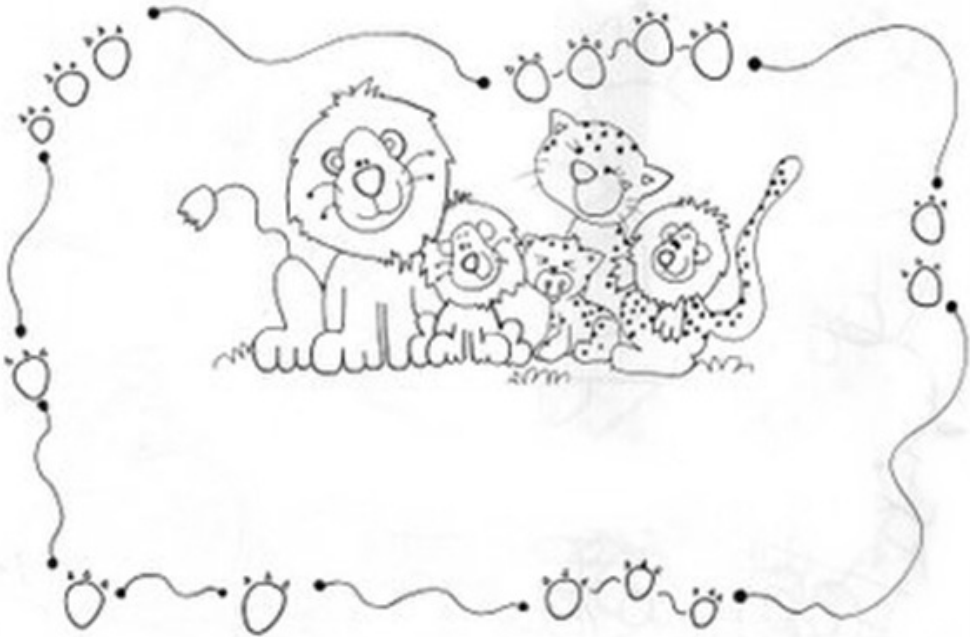
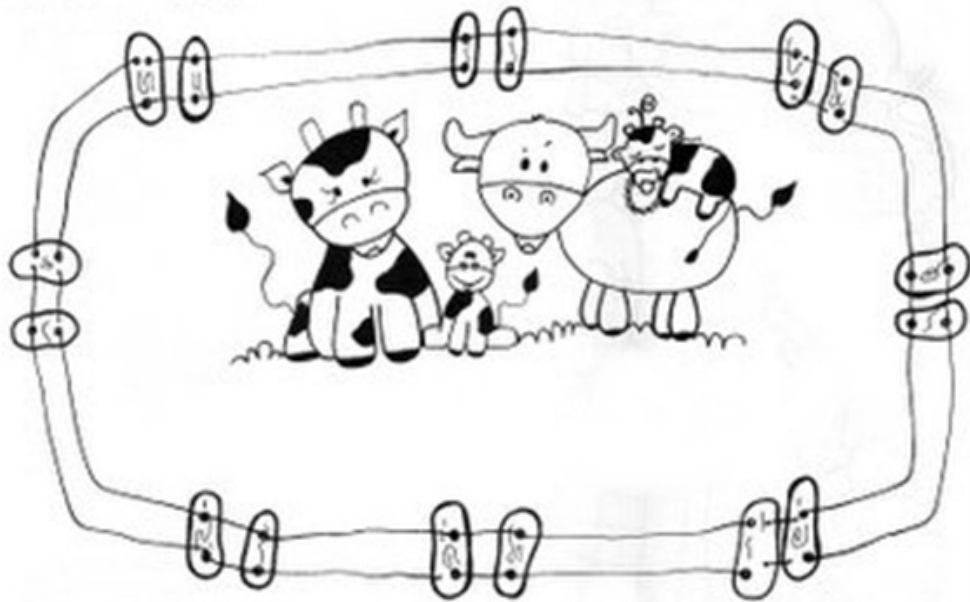

ESCOLA _____ DATA: ____ / ____ / ____

PROF: _____ TURMA: _____

NOME: _____

